

# Timken® Type E Tapered Roller Bearing Housed Units

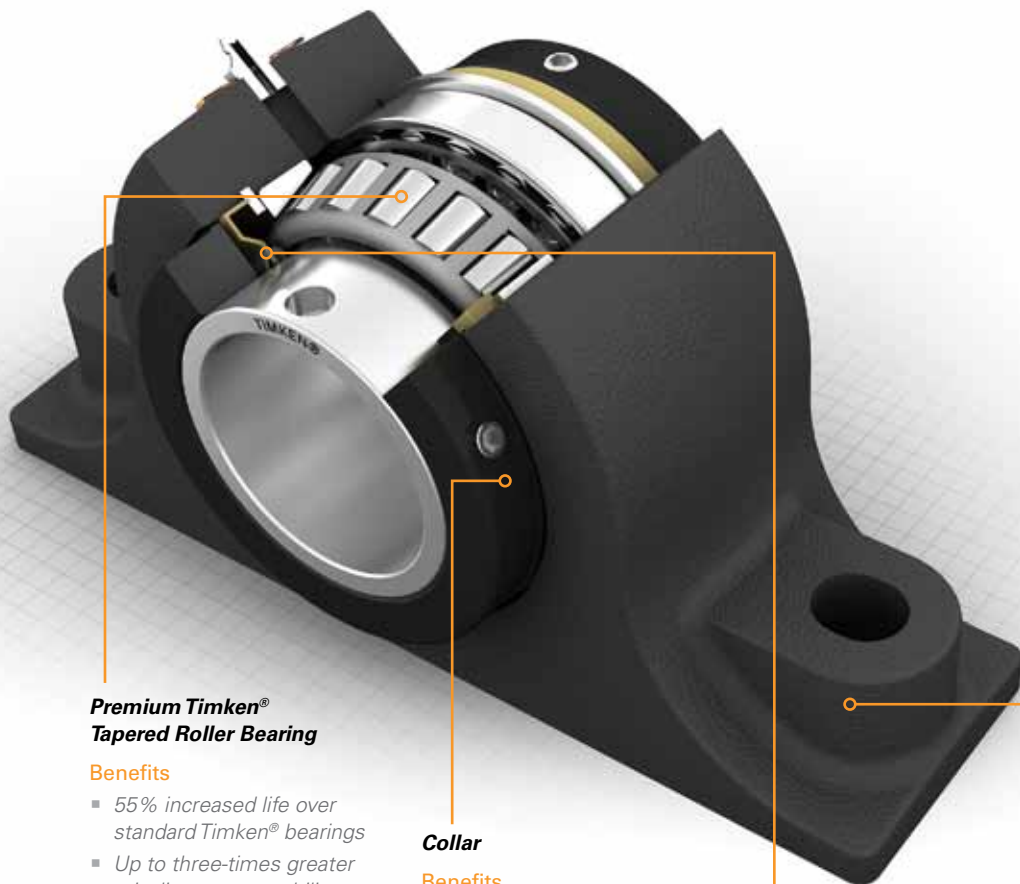

## Premium Timken® Tapered Roller Bearing

### Benefits

- 55% increased life over standard Timken® bearings
- Up to three-times greater misalignment capability
- Improved lubrication performance
- Reduced internal stresses
- Enhanced performance

### Features

- 14% more load capacity
- Optimized bearing profiles
- Improved surface textures
- Super-clean, high-alloy bearing steel

## Collar

### Benefits

- Better corrosion-resistance than black oxide and powder-coating
- All surfaces are protected with Electro-Coat for superior corrosion protection
- Maximum locking power
- Greatly reduced set screw back-out even in the most severe applications

### Features

- Electro-Coat
- 65° set screw angle
- Set screw with nylon patch
- Machined steel

## Timken-Designed Double Lip Seals

### Benefits

- Improved grease retention
- Significantly reduced contaminant ingress
- Rotating collar acts as an initial flinger

### Features

- Double lip design
- Designed to optimize lip contact

## Timken Premium All Purpose Industrial Grease

### Benefits

- Provides superior protection
- Effective in operating temperatures from -40°F to +300°F (-40°C to +149°C)
- It is compatible with calcium- and lithium-thickened greases

### Features

- Extreme pressure and anti-wear additives
- Corrosion inhibitors

## Housing

### Benefits

- Better corrosion resistance than powder coating
- Designed to Type E dimensions
- Bolt holes and shaft centerline dimensions interchangeable, conforming with industry practice

### Features

- Electro-Coat
- Material spec: ASTM – A48 Grade 30 Cast Iron

## Size Ranges

Pillow Blocks:

2-Bolt: 1-3/16" thru 3-1/2"

4-Bolt: 2-1/4" thru 5"

Flange & Take-Up Units:

1-3/16 thru 5"

# Timken® Type E Tapered Roller Bearing Housed Units

Timken Type E tapered roller bearing housed units are available in a wide variety of sizes and configurations to meet the requirements of demanding applications. They are dimensionally interchangeable with current suppliers for all key characteristics, including the bolt hole and shaft centerline dimensions. Popular part numbers are in stock for immediate availability. Metric sizes also are available in shaft diameters ranging from 35 mm to 125 mm.

Shaft Size	TIMKEN® PN	DODGE® PN	SEALMASTER® PN	Browning® PN	ROYERSFORD™ PN	MOLINE PN
<b>Pillow Block: 2-Bolt Base</b>						
1-3/16	E-P2B-TRB-1 3/16	023000 (P2B-E-103R)	RPB-103 -2 or -C2	PBE-920-1 3/16	20-02-0103	19321103
1-1/4	E-P2B-TRB-1 1/4	023001 (P2B-E-104R)	RPB-104 -2 or -C2	PBE-920-1 1/4	20-02-0104	19321104
1-3/8	E-P2B-TRB-1 3/8	023002 (P2B-E-106R)	RPB-106 -2 or -C2	PBE-920-1 3/8	20-02-0106	19321106
1-7/16	E-P2B-TRB-1 7/16	023003 (P2B-E-107R)	RPB-107 -2 or -C2	PBE-920-1 7/16	20-02-0107	19321107
1-1/2	E-P2B-TRB-1 1/2	023004 (P2B-E-108R)	RPB-108 -2 or -C2	PBE-920-1 1/2	20-02-0108	19321108
1-5/8	E-P2B-TRB-1 5/8	023005 (P2B-E-110R)	RPB-110 -2 or -C2	PBE-920-1 5/8	20-02-0110	19321110
1-11/16	E-P2B-TRB-1 11/16	023006 (P2B-E-111R)	RPB-111 -2 or -C2	PBE-920-1 11/16	20-02-0111	19321111
1-3/4	E-P2B-TRB-1 3/4	023007 (P2B-E-112R)	RPB-112 -2 or -C2	PBE-920-1 3/4	20-02-0112	19321112
1-7/8	E-P2B-TRB-1 7/8	023008 (P2B-E-114R)	N/A	N/A	20-02-0114	19321114
1-15/16	E-P2B-TRB-1 15/16	023009 (P2B-E-115R)	RPB-115 -2 or -C2	PBE-920-1 15/16	20-02-0115	19321115
2	E-P2B-TRB-2	023010 (P2B-E-200R)	RPB-200 -2 or -C2	PBE-920-2	20-02-0200	19321200
2-3/16	E-P2B-TRB-2 3/16	023011 (P2B-E-203R)	RPB-203 -2 or -C2	PBE-920-2 3/16	20-02-0203	19321203
2-1/4	E-P2B-TRB-2 1/4	023012 (P2B-E-204R)	RPB-204 -2 or -C2	PBE-920-2 1/4	20-02-0204	19321204
2-7/16	E-P2B-TRB-2 7/16	023013 (P2B-E-207R)	RPB-207 -2 or -C2	PBE-920-2 7/16	20-02-0207	19321207
2-1/2	E-P2B-TRB-2 1/2	023014 (P2B-E-208R)	RPB-208 -2 or -C2	PBE-920-2 1/2	20-02-0208	19321208
2-11/16	E-P2B-TRB-2 11/16	023015 (P2B-E-211R)	RPB-211 -2 or -C2	PBE-920-2 11/16	20-02-0211	19321211
2-3/4	E-P2B-TRB-2 3/4	023016 (P2B-E-212R)	RPB-212 -2 or -C2	PBE-920-2 3/4	20-02-0212	19321212
2-15/16	E-P2B-TRB-2 15/16	023017 (P2B-E-215R)	RPB-215 -2 or -C2	PBE-920-2 15/16	20-02-0215	19321215
3	E-P2B-TRB-3	023018 (P2B-E-300R)	RPB-300 -2 or -C2	PBE-920-3	20-02-0300	19321300
3-3/16	E-P2B-TRB-3 3/16	023019 (P2B-E-303R)	RPB-303 -2 or -C2	PBE-920-3 3/16	20-02-0303	19321303
3-1/4	E-P2B-TRB-3 1/4	023020 (P2B-E-304R)	N/A	N/A	20-02-0304	19321304
3-7/16	E-P2B-TRB-3 7/16	023021 (P2B-E-307R)	RPB-307 -2 or -C2	PBE-920-3 7/16	20-02-0307	19321307
3-1/2	E-P2B-TRB-3 1/2	023022 (P2B-E-308R)	RPB-308 -2 or -C2	PBE-920-3 1/2	20-02-0308	19321308
<b>Pillow Block: 4-Bolt Base</b>						
2-1/4	E-P4B-TRB-2 1/4	023023 (P4B-E-204R)	RPB-204 -4 or -C4	PBE-920F-2 1/4	20-04-0204	19341204
2-7/16	E-P4B-TRB-2 7/16	023024 (P4B-E-207R)	RPB-207 -4 or -C4	PBE-920F-2 7/16	20-04-0207	19341207
2-1/2	E-P4B-TRB-2 1/2	023025 (P4B-E-208R)	RPB-208 -4 or -C4	PBE-920F-2 1/2	20-04-0208	19341208
2-11/16	E-P4B-TRB-2 11/16	023026 (P4B-E-211R)	RPB-211 -4 or -C4	PBE-920F-2 11/16	20-04-0211	19341211
2-3/4	E-P4B-TRB-2 3/4	023027 (P4B-E-212R)	RPB-212 -4 or -C4	PBE-920F-2 3/4	20-04-0212	19341212
2-15/16	E-P4B-TRB-2 15/16	023028 (P4B-E-215R)	RPB-215 -4 or -C4	PBE-920F-2 15/16	20-04-0215	19341215
3	E-P4B-TRB-3	023029 (P4B-E-300R)	RPB-300 -4 or -C4	PBE-920F-3	20-04-0300	19341300
3-3/16	E-P4B-TRB-3 3/16	023030 (P4B-E-303R)	RPB-303 -4 or -C4	PBE-920F-3 3/16	20-04-0303	19341303
3-1/4	E-P4B-TRB-3 1/4	023031 (P4B-E-304R)	N/A	N/A	20-04-0304	19341304
3-7/16	E-P4B-TRB-3 7/16	023032 (P4B-E-307R)	RPB-307 -4 or -C4	PBE-920F-3 7/16	20-04-0307	19341307
3-1/2	E-P4B-TRB-3 1/2	023033 (P4B-E-308R)	RPB-308 -4 or -C4	PBE-920F-3 1/2	20-04-0308	19341308
3-15/16	E-P4B-TRB-3 15/16	023690 (P4B-E-315R)	RPB-315 -4 or -C4	PBE-920F-3 15/16	20-04-0315	19341315
4	E-P4B-TRB-4	023691 (P4B-E-400R)	RPB-400 -4 or -C4	PBE-920F-4	20-04-0400	19341400
4-7/16	E-P4B-TRB-4 7/16	023692 (P4B-E-407R)	RPB-407 -4 or -C4	PBE-920F-4 7/16	20-04-0407	19341407
4-1/2	E-P4B-TRB-4 1/2	023693 (P4B-E-408R)	RPB-408 -4 or -C4	PBE-920F-4 1/2	20-04-0408	19341408
4-15/16	E-P4B-TRB-4 15/16	023694 (P4B-E-415R)	RPB-415 -4 or -C4	PBE-920F-4 15/16	20-04-0415	19341415
5	E-P4B-TRB-5	023695 (P4B-E-500R)	RPB-500 -4 or -C4	PBE-920F-5	20-04-0500	19341500

Flange and Take-Up Units also are available. To learn more about our expanded series of Timken® roller bearing housed units and our extensive offering of other friction management products and services, contact your local Timken representative or visit [www.timken.com](http://www.timken.com).

**TIMKEN**  
Where You Turn

[www.timken.com](http://www.timken.com)

Timken® is a registered trademark of  
The Timken Company

© 2010 The Timken Company  
Printed in U.S.A.  
20M 02-10-29 Order No. 10339

Timken® Type E Tapered Roller Bearing Housed Units



## Quality and Performance Come Standard

The Timken name stands for high quality and outstanding performance. Using our capabilities in bearing technology, manufacturing, engineering support and distribution, we provide our customers with smart, cost-effective friction management and power transmission solutions that help them outperform the competition.

Our latest innovation is our new series of Timken® Type E roller housed units. Timken engineers have applied more than 110 years of expertise in bearing design – and leadership in tapered roller bearings – to bring you an optimized performance tapered roller bearing housed unit. We have improved our own design to create the new standard in performance.

At Timken, our brand stands for outstanding quality in everything we do, from product design and manufacturing to engineering support and distribution. Our commitment to quality, service and delivery adds

up to an unbeatable value for customers everywhere.

### **Quality Solutions**

As the only premium bearing manufacturer to also make super-clean, high-alloy bearing steel, we know how critical quality materials are to product performance. We also implement the Timken Quality Management System in every plant worldwide, so each bearing product meets the same high performance standards – no matter where in the world it is manufactured.

### **Dependable Service**

Our roller housed units are backed with the service of our industry-leading experts,

who are ready to assist you with product design, application knowledge and 24/7 field engineering support – anything you need to help improve uptime and maximize equipment performance.

### **On Time Delivery**

We know short lead times are critical to keeping your operations up and running. Many of our Type E roller housed units are in stock for immediate shipping. For special orders, we work quickly to manufacture and deliver your products on time.



### **Expanded Housed Unit Offering**

*From the manufacturer that brought you reliable Fafnir® ball bearing housed units and Timken® SAF® pillow blocks comes a growing line of roller housed units. We've expanded our offering to include Timken® Type E housed units featuring our own advanced tapered roller bearings and seals.*

## Common Applications

- Processing and material handling equipment used in pulp and paper, power generation, mining, cement, aggregate, mixing/vibrating, ovens/furnaces, water treatment and waste water treatment.
- Also widely used in air handling equipment.



## Designed for the Most Demanding Applications

Seal Performance (Mud/Salt Slurry Ingress Test)

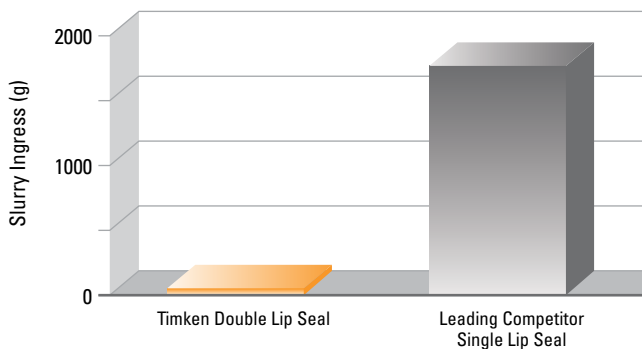

Slurry ingress test results of the optimized Timken Type E seal compared with the R seal design of a leading competitor. Seal operating at 250 rpm in a salt and mud slurry mixture for 75 hours.

Seal Performance (Water Ingress Test)

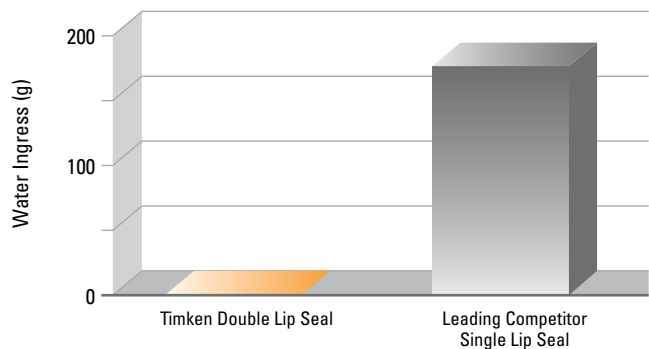

Water ingress test results of the new Timken Type E seal compared with the R seal design of a leading competitor. Seal operating at 250 rpm with three gallons of water per minute directed at the shaft-seal interface for four hours.

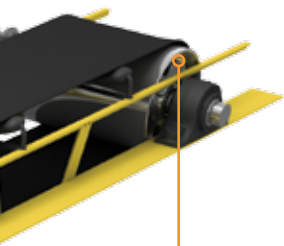

## Helping Improve Your Performance

### Bearing Materials Comparison

	Timken	Leading Competitor using Non-Timken Bearings
<b>Cone</b>	Case Carburized	Case Carburized
	Enhanced Surface Finish	Standard Surface Finish
<b>Cup</b>	Case Carburized	Thru Hardened, Sourced
	Timken Matched Cup to Cone	Unmatched Cup to Cone
<b>Roller</b>	Case Carburized	Thru Hardened Rollers
	Enhanced Profile	Limited Profile
<b>Seals</b>	Double Lip	Single Lip
<b>Housing</b>	ASTM A48 Grade 30	ASTM A48 Grade 30
	Electro-Coat Paint	Powder-Coat Paint
<b>Grease</b>	Timken All Purpose Premium Grease	Mobilith 2

### Bearing Life Analysis Comparison

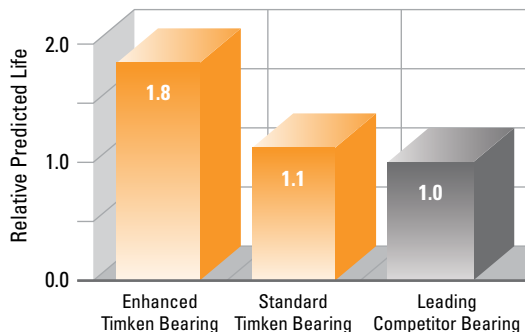

Analytical analysis of the new, optimized Timken bearing compared to a standard Timken bearing (used widely by most Type E suppliers) and a new bearing from a leading industry competitor.

Note: Life tests of Timken tapered roller bearings verified by Germanischer Lloyd.

### Surface Texture Finish

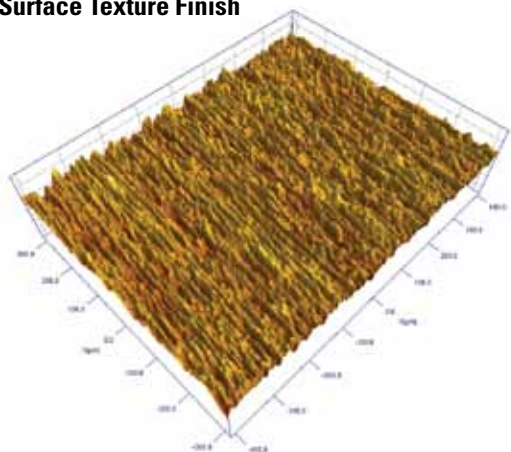

Enhanced Timken Bearing Textures

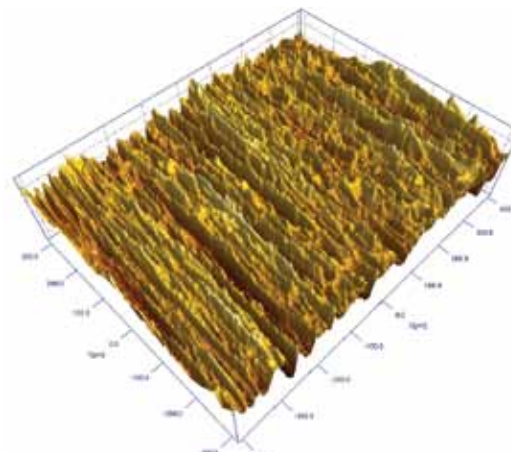

Leading Competitor Bearing Textures

3-D surface maps created with the use of a white light interferometric microscope.

### Race Stress Plot

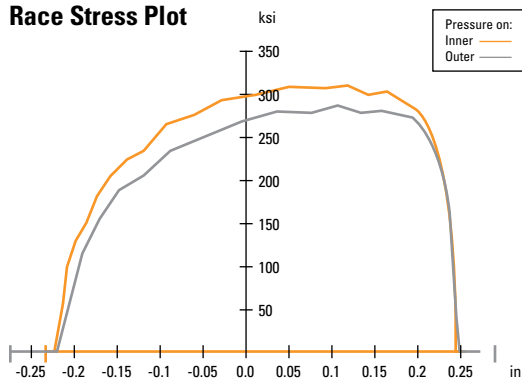

Enhanced Timken Bearing with Optimized Profiles

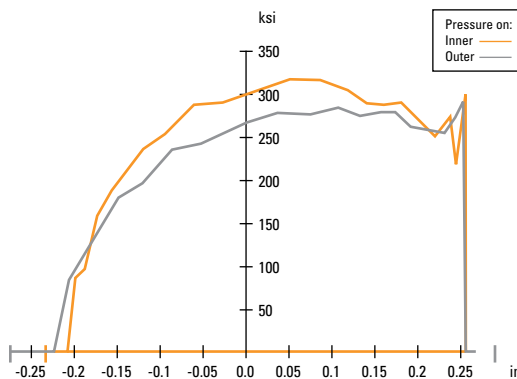

Leading Competitor Bearing

Based on rated load, 0.5 mrad misalignment and actual measured profiles.